

WPT2N32

Single, PNP, -30V, -1A, Power Transistor with 20V N-MOSFET

[Http://www.willsemi.com](http://www.willsemi.com)

Descriptions

The WPT2N32 is PNP bipolar power transistor with 20V N-MOSFET. This device is suitable for use in charging circuit and other power management. Standard Product WPT2N32 is Pb-free.

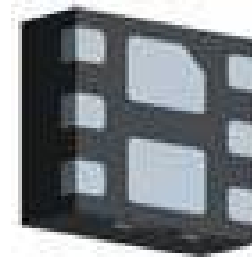

DFN2x2-6L

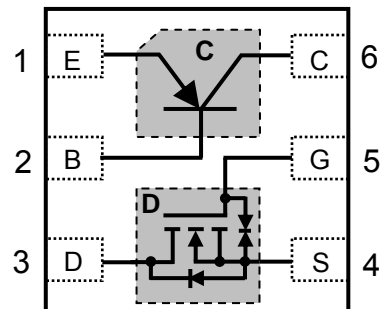

Pin configuration (Top view)

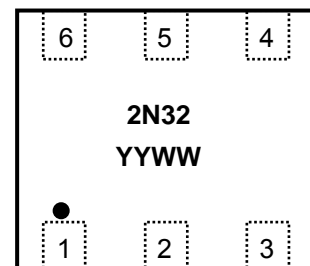

2N32 = Device code
 YY = Year
 WW = Week
Marking

Features

- Ultra low collector-to-emitter saturation voltage
- High DC current gain >100
- 1A continue collector current
- Small package DFN2x2-6L

Applications

- Charging circuit
- Other power management in portable equipments

Order information

Device	Package	Shipping
WPT2N32-6/TR	DFN2x2-6L	3000/Reel&Tape

Absolute maximum ratings

Parameter	Symbol	Value	Unit
PNP Transistor			
Collector-emitter voltage	V_{CEO}	-30	V
Collector-base voltage	V_{CBO}	-30	V
Emitter-base voltage	V_{EBO}	-6	V
Continues collector current ^b	I_C	-1	A
Pulse collector current ^c	I_{CM}	-3	A
N-MOSFET			
Drain-Source Voltage	V_{DS}	20	V
Gate-Source Voltage	V_{GS}	± 6	V
Continuous Drain Current ^a	I_D	0.80	A
Continuous Drain Current ^b		0.69	A
Pulsed Drain Current ^c	I_{DM}	1.4	A
Power Dissipation and temperature			
Power dissipation ^a	P_D	1.1	W
Power dissipation ^b		0.6	W
Junction Temperature	T_J	150	°C
Lead Temperature	T_L	260	°C
Operation Temperature	T_A	-40 ~ 85	°C
Storage Temperature Range	T_{stg}	-55 to 150	°C

Thermal resistance ratings

Parameter	Symbol	Value	Unit
Junction-to-Ambient Thermal Resistance ^a	$R_{\theta JA}$	113	°C/W
Junction-to-Ambient Thermal Resistance ^b	$R_{\theta JA}$	208	°C/W

- a Surface mounted on FR-4 Board using 1 square inch pad size, 1oz copper
- b Surface mounted on FR-4 board using minimum pad size, 1oz copper
- c Pulse width=300 μ s, Duty Cycle<2%
- d Maximum junction temperature $T_J=150^\circ\text{C}$.

Electronics Characteristics (Ta=25°C, unless otherwise noted)

Parameter	Symbol	Test Conditions	Min.	Typ.	Max.	Unit
PNP Transistor						
Collector-emitter breakdown voltage	BV_{CEO}	$I_C=-10mA, I_B=0mA$	-32			V
Collector-base breakdown voltage	BV_{CBO}	$I_C=-1mA, I_E=0mA$	-32			V
Emitter-base breakdown voltage	BV_{EBO}	$I_E=-100\mu A, I_C=0mA$	-6			V
Collector cutoff current	I_{CBO}	$V_{CB}=-30V, I_E=0$			-100	nA
Emitter cutoff current	I_{EBO}	$V_{EB}=-5V, I_C=0$			-100	nA
Collector-emitter saturation voltage	$V_{CE(sat)}$	$I_C=-0.5A, I_B=-50mA$		-0.1	-0.35	V
Base-emitter saturation voltage	$V_{BE(sat)}$	$I_C=-0.5A, I_B=-50mA$		-0.9	-1.5	V
Base-emitter forward voltage	$V_{BE(on)}$	$I_C=-0.5A, V_{CE}=-2V$		-0.7	-1.1	V
DC current gain	h_{FE}	$I_C=-0.5A, V_{CE}=-2V$	100		300	
N-MOSFET						
Drain-Source Breakdown Voltage	$V_{(BR)DSS}$	$V_{GS}=0V, I_D=250\mu A$	20			V
Zero Gate Voltage Drain Current	I_{DSS}	$V_{DS}=16V, V_{GS}=0V$			100	nA
Gate –Source leakage current	I_{GSS}	$V_{DS}=0V, V_{GS}=\pm 5V$			± 1	μA
Gate Threshold Voltage	$V_{GS(th)}$	$V_{DS}=V_{GS}, I_D=250\mu A$	0.44	0.55	0.86	V
Drain-Source On-Resistance	$R_{DS(on)}$	$V_{GS}=4.5V, I_D=0.55A$		205	600	m Ω
		$V_{GS}=2.5V, I_D=0.50A$		295	650	m Ω
		$V_{GS}=1.8V, I_D=0.35A$		320	700	m Ω
Input Capacitance	C_{iss}	$V_{DS}=10V,$		61		pF
Output Capacitance	C_{oss}	$V_{GS}=0V,$		17		pF
Reverse Transfer Capacitance	C_{rss}	$F=100KHZ$		10		pF
Total Gate Charge	$Q_{G(TOT)}$	$V_{DS}=10V,$ $V_{GS}=4.5V,$ $I_D=0.6A$		1.15		nC
Threshold gate charge	$Q_{G(TH)}$			0.06		nC
Gate-Source Charge	Q_{GS}			0.15		nC
Gate-Drain Charge	Q_{GD}			0.23		nC
Turn-On Delay Time	$t_{d(on)}$			33		ns
Turn-On Rise Time	t_r	$V_{DD}=10V, V_{GS}=4.5V,$ $I_D=0.5A,$		102		ns
Turn-Off Delay Time	$t_{d(off)}$	$R_L=10\Omega, R_G=6\Omega$		790		ns
Turn-Off Fall Time	t_f			439		ns
Body Diode Forward Voltage	V_{SD}	$V_{GS}=0V, I_S=0.35A$	0.5	0.7	1.1	V

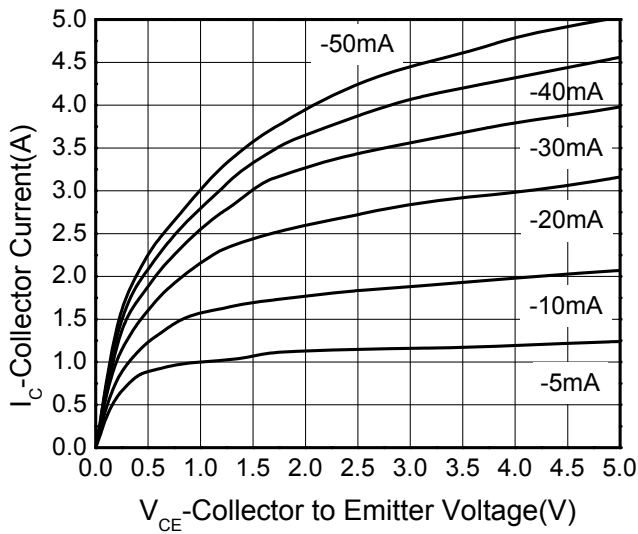
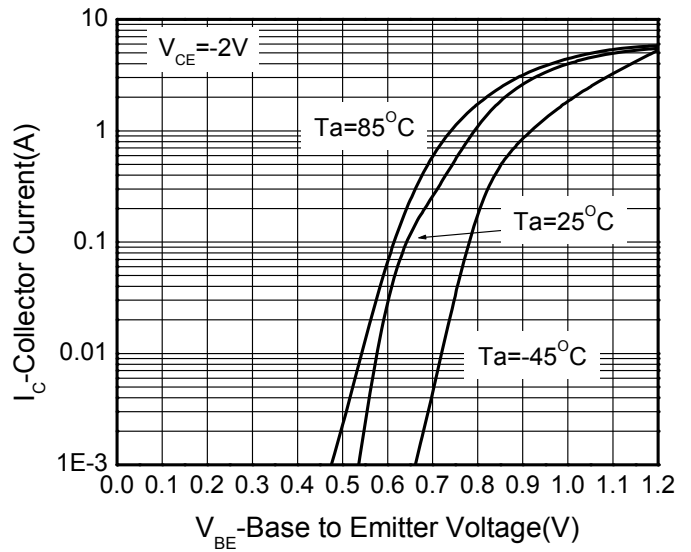
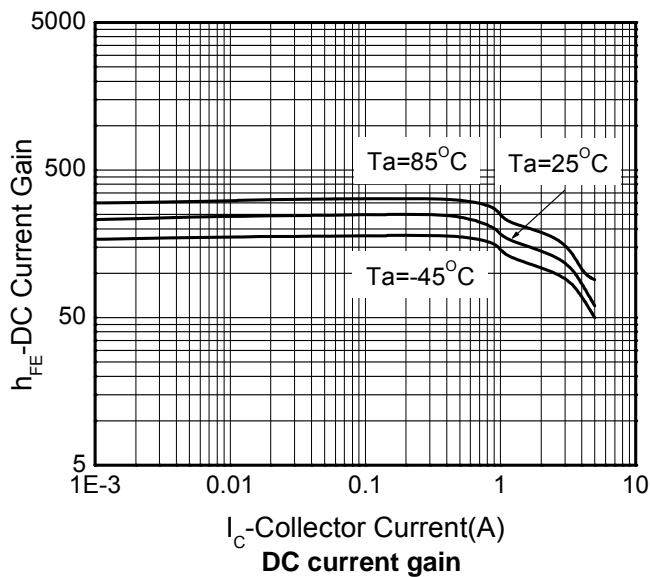
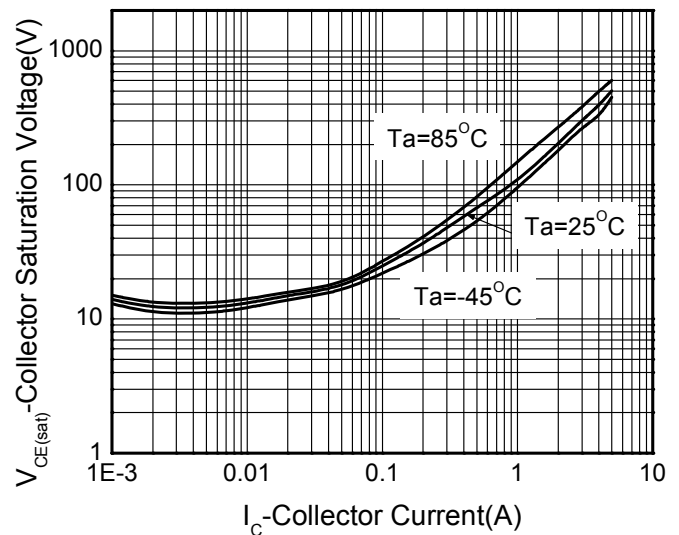
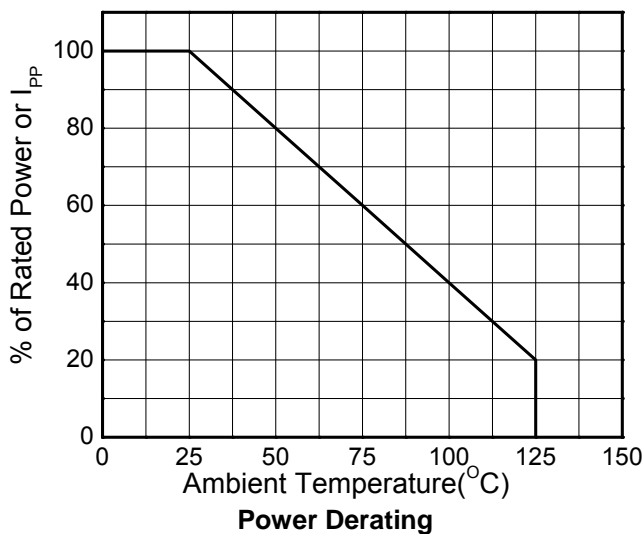
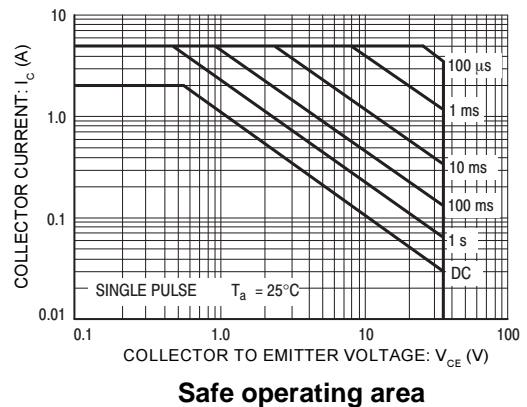
Typical Characteristics (Ta=25°C, unless otherwise noted)
PNP Transistor

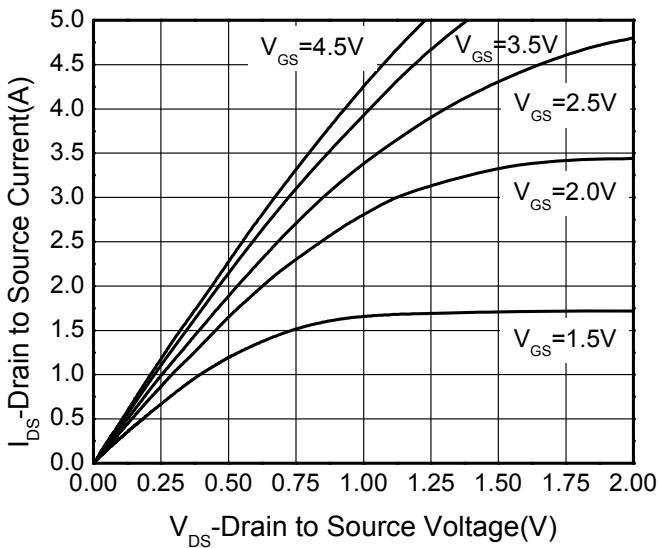
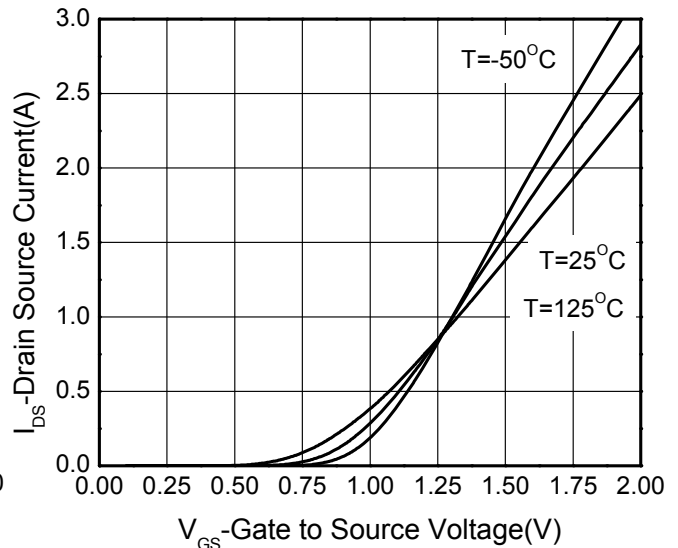
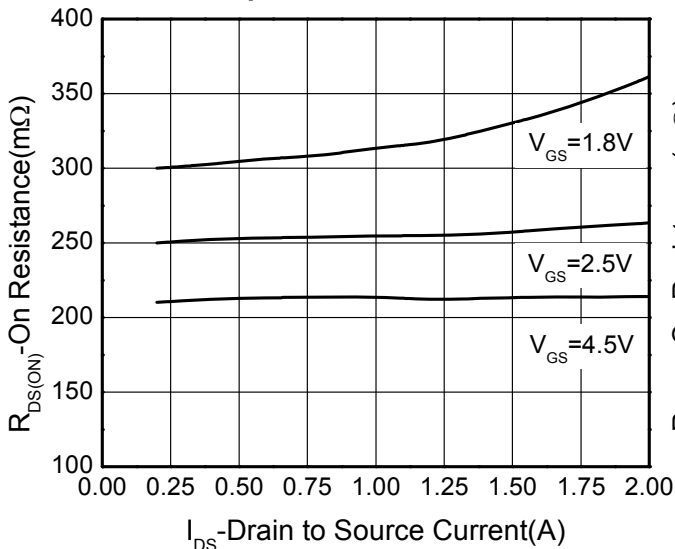
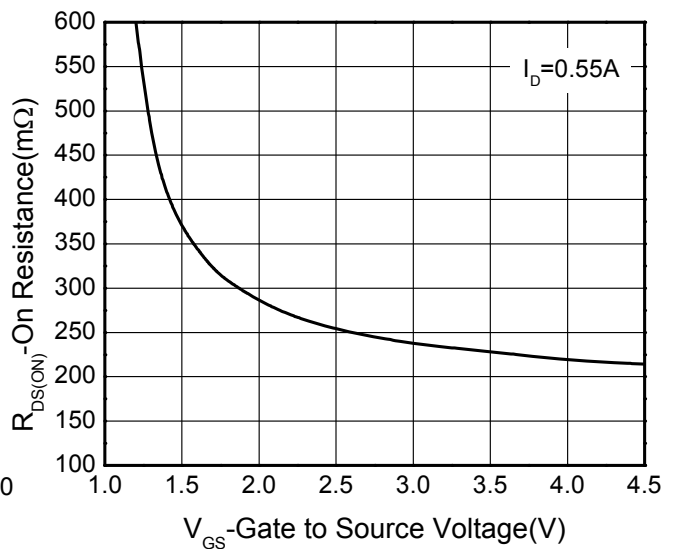
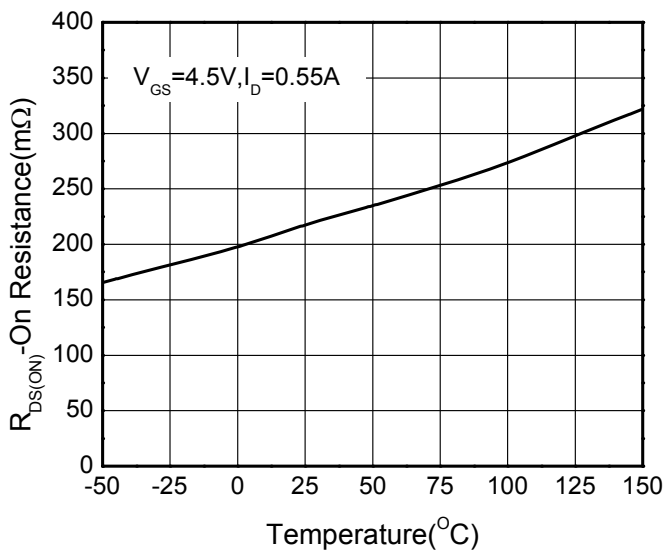
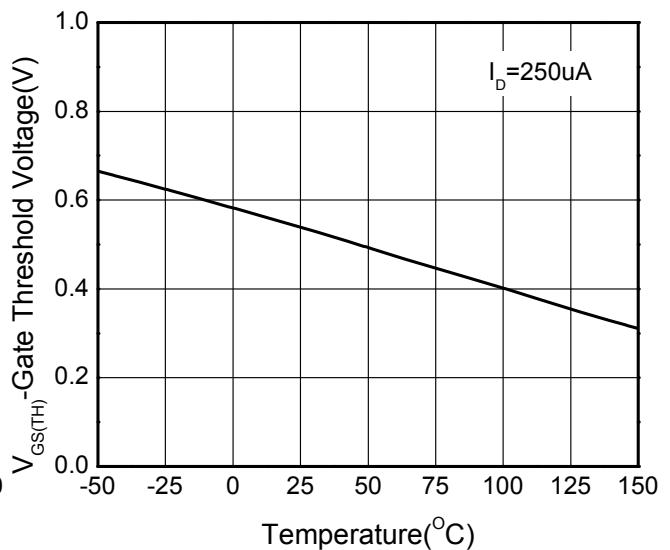
Output characteristics

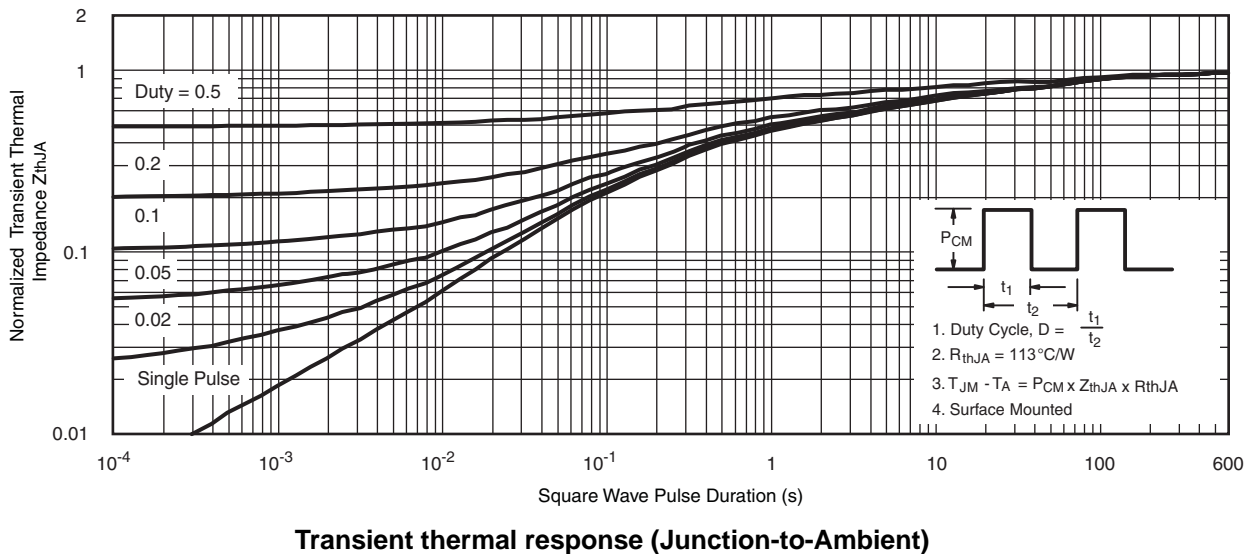
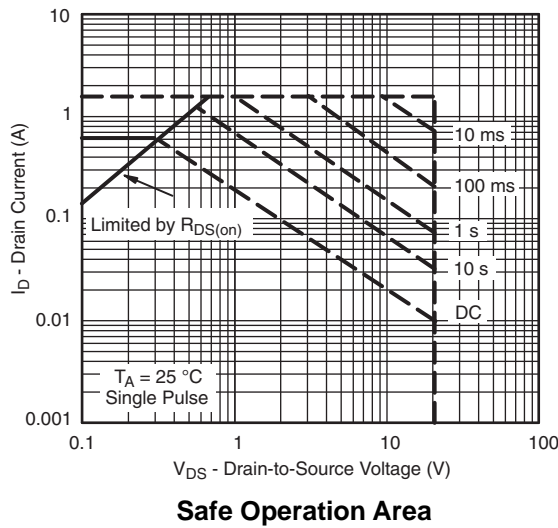
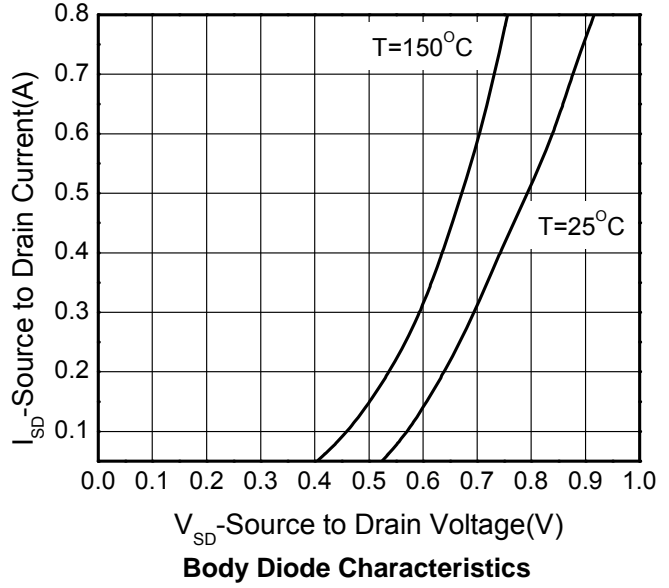
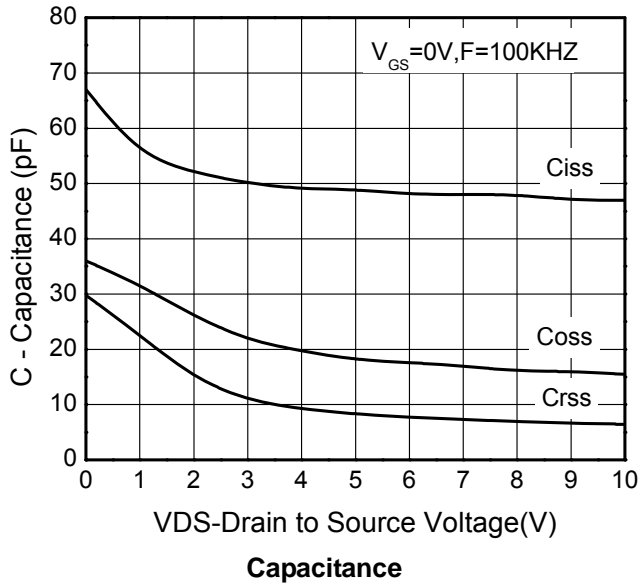
Transfer characteristics

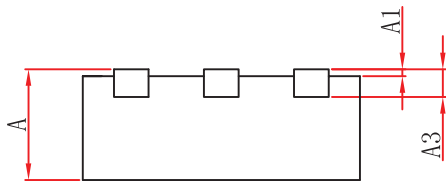
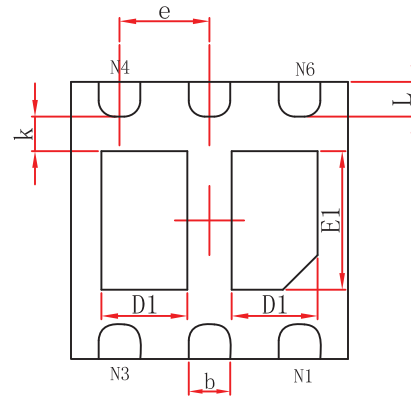
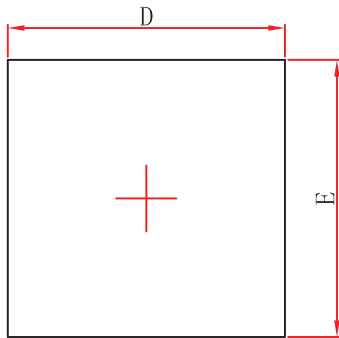
DC current gain

C-E saturation voltage vs. Collector current

Power Derating

Safe operating area

N-MOSFET

Output Characteristics

Transfer Characteristics

ON Resistance vs. Drain Current

ON Resistance vs. Gate-to-Source Voltage

ON Resistance vs. Junction Temperature

Threshold Voltage vs. Temperature



Package outline dimensions
DFN2x2-6L

Symbol	Dimension in Millimeters		
	Min.	Typ.	Max.
A	0.700	0.750	0.800
A1	0.000	0.025	0.050
A3	0.203REF		
D	1.900	2.000	2.100
E	1.900	2.000	2.100
E1	0.750	0.800	0.850
D1	0.600	0.650	0.700
k	0.200MIN		
b	0.250	0.300	0.350
e	0.650TYP		
L	0.250	0.300	0.350