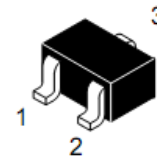
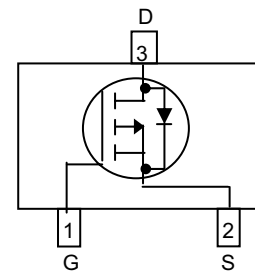
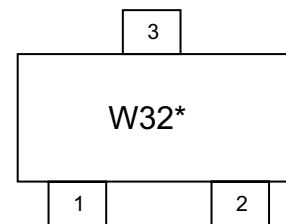

WPM3012
Single P-Channel, -30V, -3.1A, Power MOSFET
[Http://www.sh-willsemi.com](http://www.sh-willsemi.com)

V_{DS} (V)	$R_{ds(on)}$ (Ω)
-30	0.058@ $V_{GS}=-10V$
	0.080@ $V_{GS}=-4.5V$

SOT-23

Pin configuration (Top view)

W32= Device Code
 * = Month (A~Z)

Marking
Descriptions

The WPM3012 is P-Channel enhancement MOS Field Effect Transistor. Uses advanced trench technology and design to provide excellent $R_{DS(ON)}$ with low gate charge. This device is suitable for use in DC-DC conversion, power switch and charging circuit. Standard Product WPM3012 is Pb-free and Halogen-free.

Features

- Trench Technology
- Supper high density cell design
- Excellent ON resistance for higher DC current
- Extremely Low Threshold Voltage
- Small package SOT-23

Applications

- Driver for Relay, Solenoid, Motor, LED etc.
- DC-DC converter circuit
- Power Switch
- Load Switch
- Charging

Order information

Device	Package	Shipping
WPM3012-3/TR	SOT-23	3000/Reel&Tape

Absolute Maximum ratings

Parameter		Symbol	10 S	Steady State	Unit
Drain-Source Voltage		V_{DS}	-30		V
Gate-Source Voltage		V_{GS}	± 20		
Continuous Drain Current ^a	$T_A=25^\circ\text{C}$	I_D	-3.1	-2.9	A
	$T_A=70^\circ\text{C}$		-2.5	-2.3	
Maximum Power Dissipation ^a	$T_A=25^\circ\text{C}$	P_D	0.9	0.8	W
	$T_A=70^\circ\text{C}$		0.6	0.5	
Continuous Drain Current ^b	$T_A=25^\circ\text{C}$	I_D	-2.8	-2.6	A
	$T_A=70^\circ\text{C}$		-2.2	-2.1	
Maximum Power Dissipation ^b	$T_A=25^\circ\text{C}$	P_D	0.7	0.6	W
	$T_A=70^\circ\text{C}$		0.5	0.4	
Pulsed Drain Current ^c		I_{DM}	-15		A
Operating Junction Temperature		T_J	150		$^\circ\text{C}$
Lead Temperature		T_L	260		$^\circ\text{C}$
Storage Temperature Range		T_{stg}	-55 to 150		$^\circ\text{C}$

Thermal resistance ratings

Parameter		Symbol	Typical	Maximum	Unit
Junction-to-Ambient Thermal Resistance ^a	$t \leq 10 \text{ s}$	$R_{\theta JA}$	105	130	$^\circ\text{C/W}$
	Steady State		120	155	
Junction-to-Ambient Thermal Resistance ^b	$t \leq 10 \text{ s}$	$R_{\theta JA}$	130	160	
	Steady State		145	190	
Junction-to-Case Thermal Resistance		$R_{\theta JC}$	60	75	

a Surface mounted on FR-4 Board using 1 square inch pad size, 1oz copper

b Surface mounted on FR-4 board using minimum pad size, 1oz copper

c Pulse width < 380 μs , Duty Cycle < 2%

d Maximum junction temperature $T_J=150^\circ\text{C}$.

Electronics Characteristics (Ta=25°C, unless otherwise noted)

Parameter	Symbol	Test Conditions	Min	Typ	Max	Unit
OFF CHARACTERISTICS						
Drain-to-Source Breakdown Voltage	BV_{DSS}	$V_{GS} = 0\text{ V}, I_D = -250\mu\text{A}$	-30			V
Zero Gate Voltage Drain Current	I_{DSS}	$V_{DS} = -24\text{V}, V_{GS} = 0\text{V}$			-1	μA
Gate-to-source Leakage Current	I_{GSS}	$V_{DS} = 0\text{ V}, V_{GS} = \pm 20\text{V}$			± 100	nA
ON CHARACTERISTICS						
Gate Threshold Voltage	$V_{GS(TH)}$	$V_{GS} = V_{DS}, I_D = -250\mu\text{A}$	-1.5	-1.9	-2.5	V
Drain-to-source On-resistance ^{b, c}	$R_{DS(on)}$	$V_{GS} = -10\text{V}, I_D = -3.1\text{A}$		58	68	m Ω
		$V_{GS} = -4.5\text{V}, I_D = -2.8\text{A}$		80	95	
Forward Transconductance	g_{FS}	$V_{DS} = -5\text{ V}, I_D = -5.0\text{A}$		8.2		s
CAPACITANCES, CHARGES						
Input Capacitance	C_{ISS}	$V_{GS} = 0\text{ V},$ $f = 1.0\text{ MHz},$ $V_{DS} = -20\text{V}$		654		pF
Output Capacitance	C_{OSS}			67		
Reverse Transfer Capacitance	C_{RSS}			56		
Total Gate Charge	$Q_{G(TOT)}$	$V_{GS} = -10\text{ V},$ $V_{DS} = -15\text{V},$ $I_D = -3.1\text{A}$		1.55		nC
Threshold Gate Charge	$Q_{G(TH)}$			2.03		
Gate-to-Source Charge	Q_{GS}			3.15		
Gate-to-Drain Charge	Q_{GD}			12.9		
SWITCHING CHARACTERISTICS						
Turn-On Delay Time	$t_d(ON)$	$V_{GS} = -10\text{ V},$ $V_{DS} = -15\text{ V},$ $R_L = 5\Omega,$ $R_G = 15\Omega$		9.6		ns
Rise Time	t_r			4.0		
Turn-Off Delay Time	$t_d(OFF)$			34.8		
Fall Time	t_f			7.2		
BODY DIODE CHARACTERISTICS						
Forward Voltage	V_{SD}	$V_{GS} = 0\text{ V}, I_S = -1.0\text{A}$		-0.8	-1.5	V

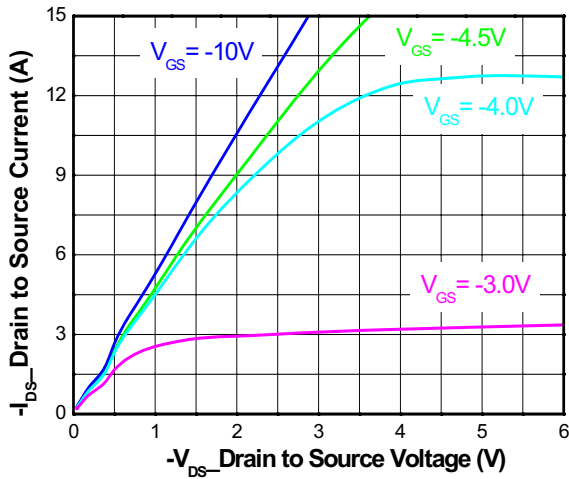
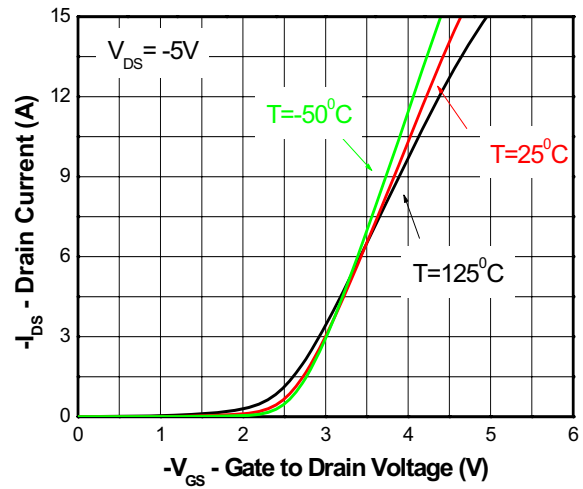
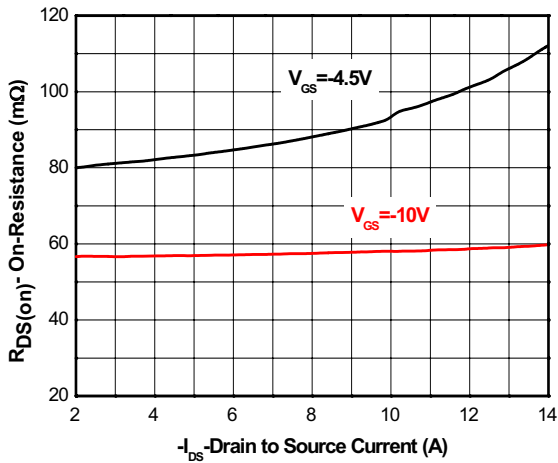
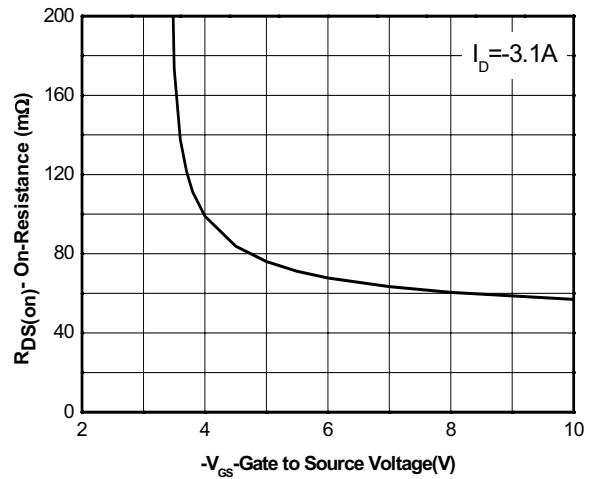
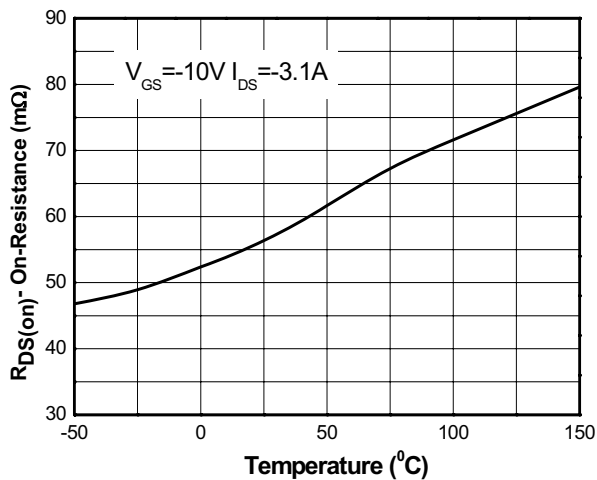
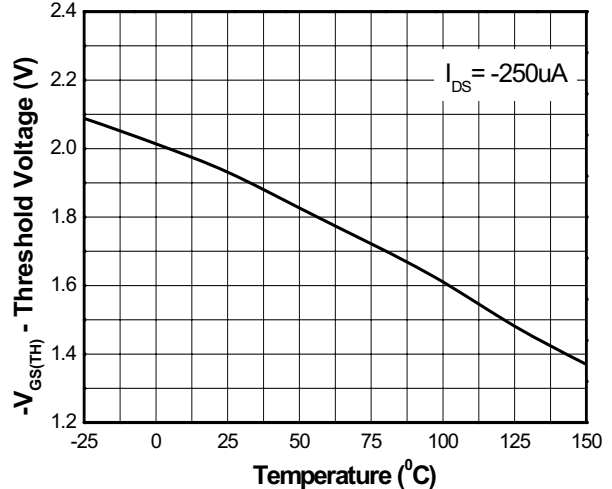
Typical Characteristics (Ta=25°C, unless otherwise noted)

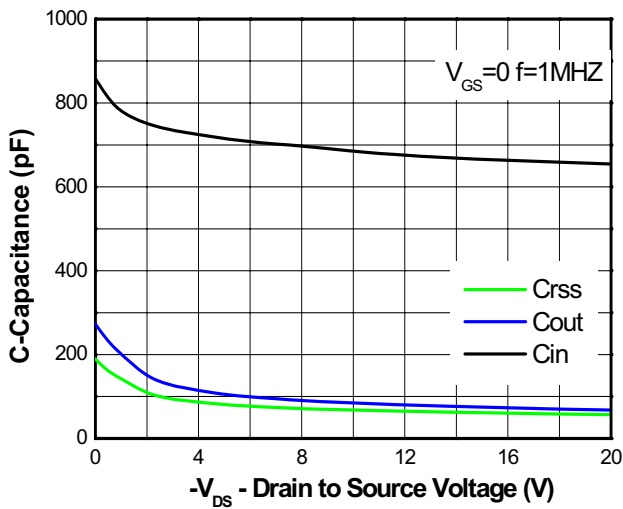
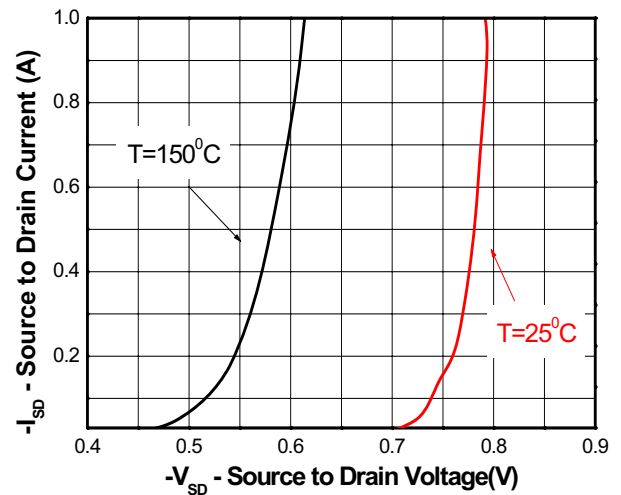
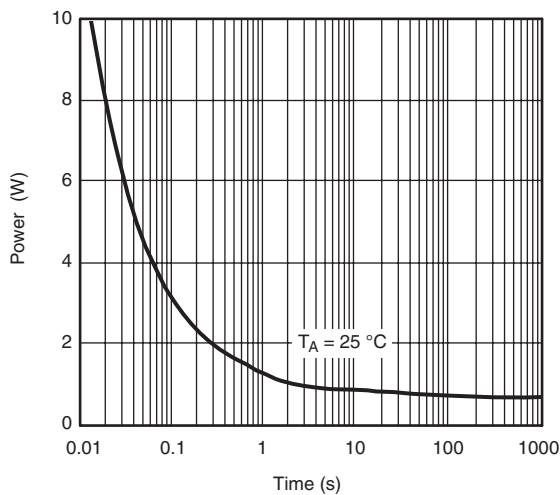
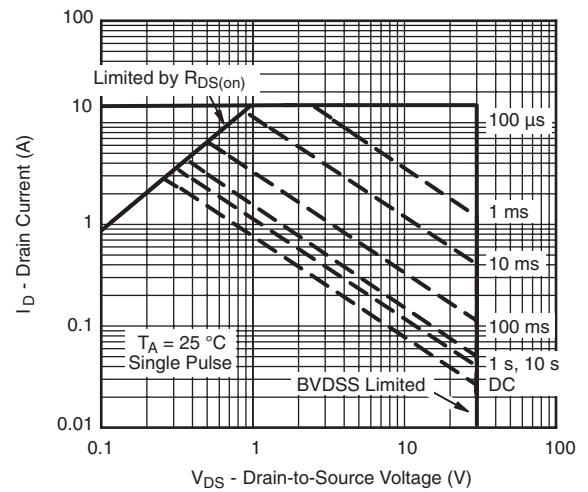
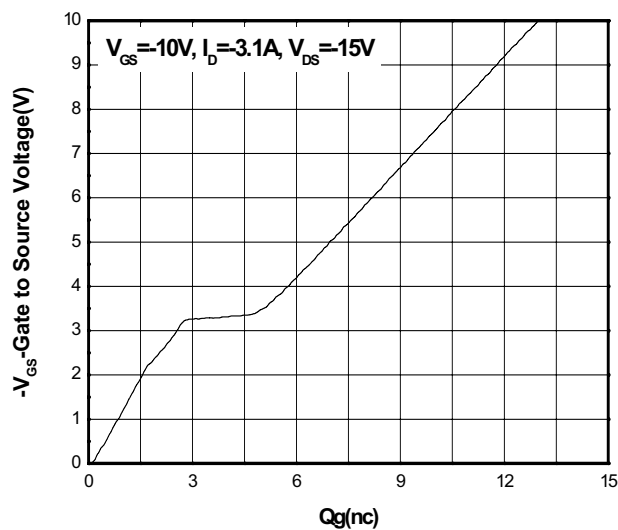
Output characteristics

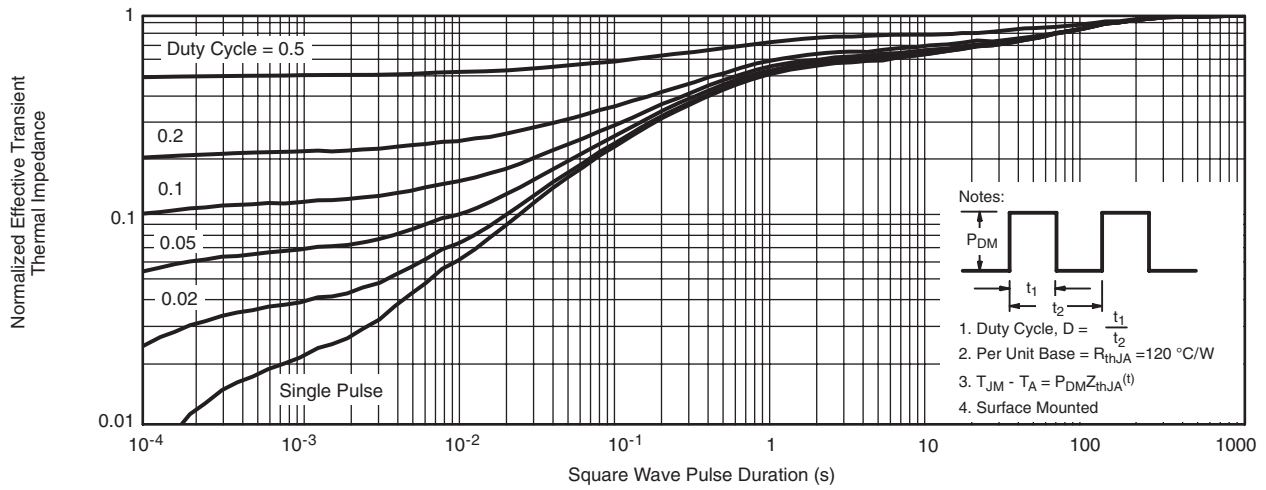
Transfer characteristics

On-Resistance vs. Drain current

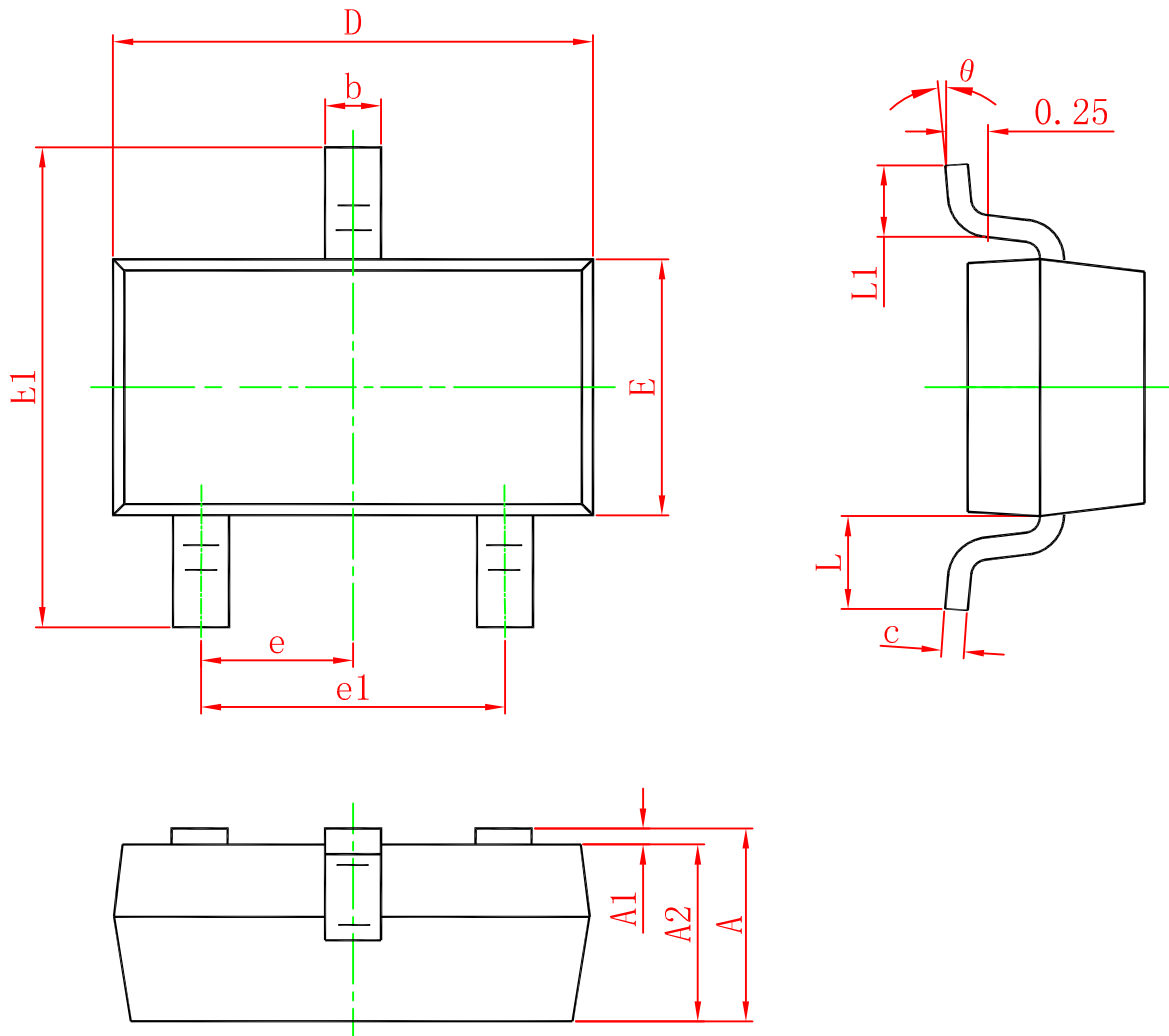
On-Resistance vs. Gate-to-Source voltage

On-Resistance vs. Junction temperature

Threshold voltage vs. Temperature

Capacitance

Body diode forward voltage

Single pulse power

Safe operating power

Gate Charge Characteristics



Transient thermal response (Junction-to-Ambient)

Package outline dimensions
SOT-23

Symbol	Dimensions in millimeter		
	Min.	Typ.	Max.
A	0.900	1.025	1.150
A1	0.000	0.050	0.100
A2	0.900	0.975	1.050
b	0.300	0.400	0.500
c	0.080	0.115	0.150
D	2.800	2.900	3.000
E	1.200	1.300	1.400
E1	2.250	2.400	2.550
e	0.950TYP		
e1	1.800	1.900	2.000
L	0.550REF		
L1	0.300		0.500
θ	0°		8°