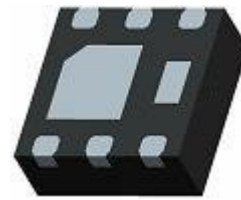
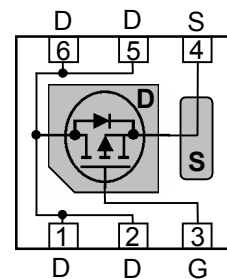

WPM2014
Single P-Channel, -20V, -4.9A, Power MOSFET
[Http://www.sh-willsemi.com](http://www.sh-willsemi.com)

V_{DS} (V)	$R_{ds(on)}$ (Ω)
-20	0.050 @ $V_{GS} = -4.5V$
	0.063 @ $V_{GS} = -2.5V$
	0.074 @ $V_{GS} = -1.8V$

DFN2x2-6L
Descriptions

The WPM2014 is P-Channel enhancement MOS Field Effect Transistor. Uses advanced trench technology and design to provide excellent $R_{DS(ON)}$ with low gate charge. This device is suitable for use in DC-DC conversion, power switch and charging circuit. Standard Product WPM2014 is Pb-free.

Pin configuration (Top view)
Features

- Trench Technology
- Supper high density cell design
- Excellent ON resistance for higher DC current
- Extremely Low Threshold Voltage
- Small package DFN2x2-6L

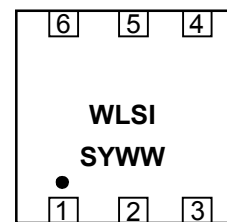

WLSI = Company code
S = Device code
Y = Year (Last digit)
WW = Week
Marking

Applications

- Driver for Relay, Solenoid, Motor, LED etc.
- DC-DC converter circuit
- Power Switch
- Load Switch
- Charging

Order information

Device	Package	Shipping
WPM2014-6/TR	DFN2x2-6L	3000/Reel&Tape

ABSOLUTE MAXIMUM RATINGS (Ta = 25 °C, unless otherwise noted)					
Parameter		Symbol	10 S	Steady State	Unit
Drain-Source Voltage		V_{DS}	-20		V
Gate-Source Voltage		V_{GS}	± 8		
Continuous Drain Current ($T_J = 150\text{ }^\circ\text{C}$) ^a	$T_A=25\text{ }^\circ\text{C}$	I_D	-4.9	-4.1	A
	$T_A=70\text{ }^\circ\text{C}$		-3.9	-3.2	
Maximum Power Dissipation ^a	$T_A=25\text{ }^\circ\text{C}$	P_D	2.0	1.4	W
	$T_A=70\text{ }^\circ\text{C}$		1.3	0.9	
Continuous Drain Current ($T_J = 150\text{ }^\circ\text{C}$) ^b	$T_A=25\text{ }^\circ\text{C}$	I_D	-3.5	-2.9	A
	$T_A=70\text{ }^\circ\text{C}$		-2.8	-2.3	
Maximum Power Dissipation ^b	$T_A=25\text{ }^\circ\text{C}$	P_D	1.0	0.7	W
	$T_A=70\text{ }^\circ\text{C}$		0.6	0.4	
Pulsed Drain Current ^c		I_{DM}	-20		A
Operating Junction Temperature		T_J	150		$^\circ\text{C}$
Storage Temperature Range		T_{stg}	-55 to 150		$^\circ\text{C}$

THERMAL RESISTANCE RATINGS					
Parameter		Symbol	Typical	Maximum	Unit
Junction-to-Ambient Thermal Resistance ^a	$t \leq 10\text{ s}$	$R_{\theta JA}$	45	60	$^\circ\text{C/W}$
	Steady State		62	85	
Junction-to-Ambient Thermal Resistance ^b	$t \leq 10\text{ s}$	$R_{\theta JA}$	80	115	
	Steady State		120	170	
Junction-to-Case Thermal Resistance		$R_{\theta JC}$	32	40	

- a Surface mounted on FR4 Board using 1 in sq pad size, 1oz Cu.
- b Surface mounted on FR4 board using the minimum recommended pad size, 1oz Cu.
- c Repetitive rating, pulse width limited by junction temperature, $t_p=10\mu\text{s}$, Duty Cycle=1%
- d Repetitive rating, pulse width limited by junction temperature $T_{J(MAX)}=150\text{ }^\circ\text{C}$.

Electronics Characteristics (Ta=25°C, unless otherwise noted)

Parameter	Symbol	Test Conditions	Min	Typ	Max	Unit
OFF CHARACTERISTICS						
Drain-to-Source Breakdown Voltage	BV_{DSS}	$V_{GS} = 0\text{ V}, I_D = -250\mu\text{A}$	-20			V
Zero Gate Voltage Drain Current	I_{DSS}	$V_{DS} = -16\text{ V}, V_{GS} = 0\text{ V}$			-1	μA
Gate-to-source Leakage Current	I_{GSS}	$V_{DS} = 0\text{ V}, V_{GS} = \pm 8.0\text{ V}$			± 100	nA
ON CHARACTERISTICS						
Gate Threshold Voltage	$V_{GS(TH)}$	$V_{GS} = V_{DS}, I_D = -250\mu\text{A}$	-0.4	-0.55	-0.9	V
Drain-to-source On-resistance	$R_{DS(on)}$	$V_{GS} = -4.5\text{ V}, I_D = -4.0\text{ A}$		50	60	m Ω
		$V_{GS} = -2.5\text{ V}, I_D = -3.5\text{ A}$		63	72	
		$V_{GS} = -1.8\text{ V}, I_D = -2.3\text{ A}$		74	98	
Forward Transconductance	g_{FS}	$V_{DS} = -5\text{ V}, I_D = -3.5\text{ A}$		10		S
CHARGES, CAPACITANCES AND GATE RESISTANCE						
Input Capacitance	C_{ISS}	$V_{GS} = 0\text{ V}, f = 1.0\text{ MHz},$ $V_{DS} = -6\text{ V}$		1200		pF
Output Capacitance	C_{OSS}			130		
Reverse Transfer Capacitance	C_{RSS}			115		
Total Gate Charge	$Q_{G(TOT)}$	$V_{GS} = -4.5\text{ V}, V_{DS} = -6\text{ V},$ $I_D = -3.3\text{ A}$		11.5		nC
Threshold Gate Charge	$Q_{G(TH)}$			0.7		
Gate-to-Source Charge	Q_{GS}			1.0		
Gate-to-Drain Charge	Q_{GD}			1.5		
SWITCHING CHARACTERISTICS						
Turn-On Delay Time	$t_d(ON)$	$V_{GS} = -4.5\text{ V}, V_{DS} = -6\text{ V},$ $R_L = 6\ \Omega, R_G = 3\ \Omega$		7.6		ns
Rise Time	t_r			5.5		
Turn-Off Delay Time	$t_d(OFF)$			62		
Fall Time	t_f			18		
DRAIN-to-SOURCE DIODE CHARACTERISTICS						
Forward Voltage	V_{SD}	$V_{GS} = 0\text{ V}, I_S = -1.6\text{ A}$	-0.5	-0.74	-1.5	V

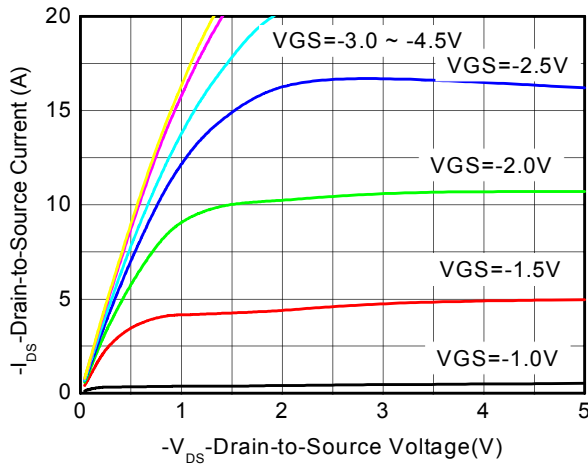
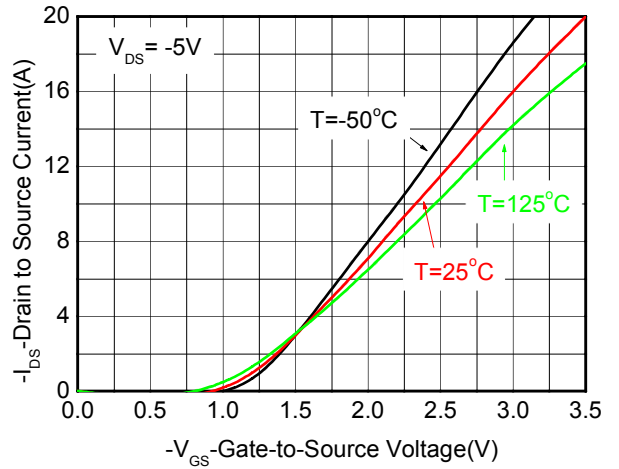
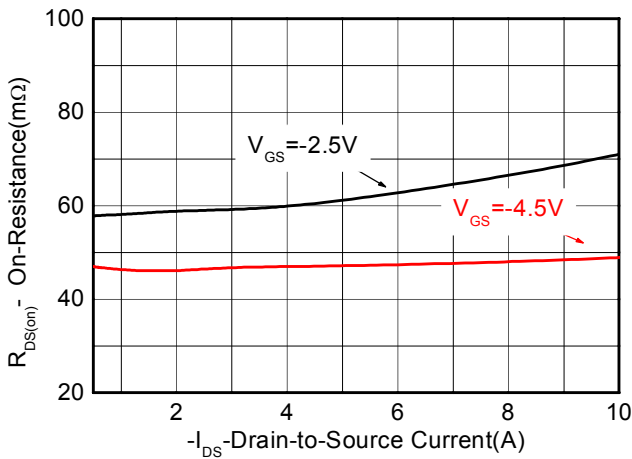
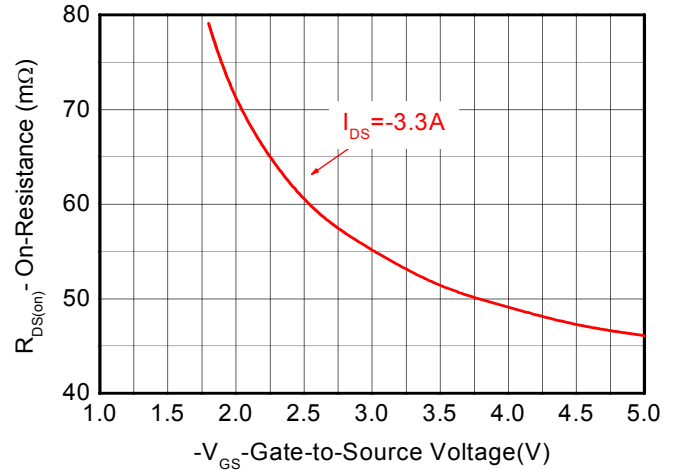
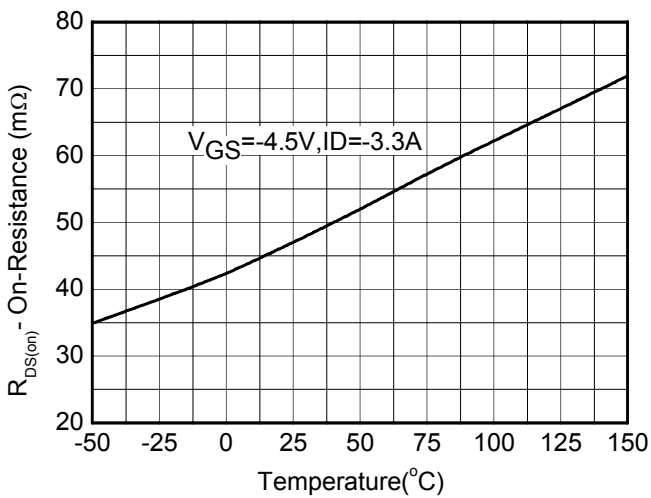
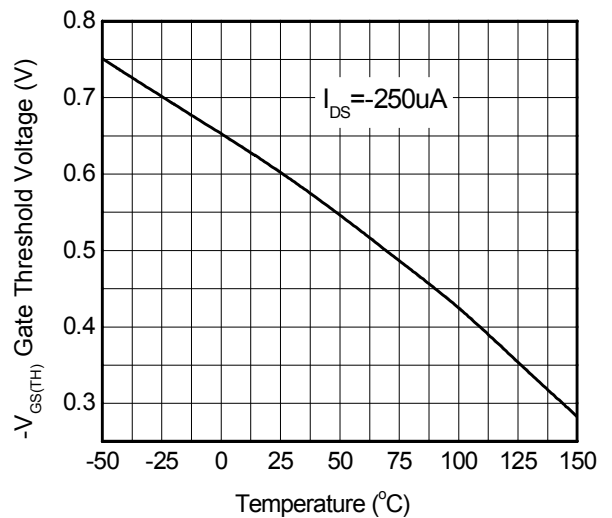
Typical Characteristics (Ta=25°C, unless otherwise noted)

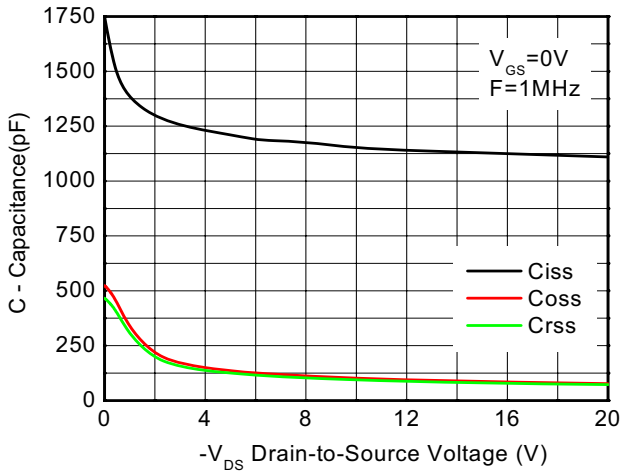
Output characteristics

Transfer characteristics

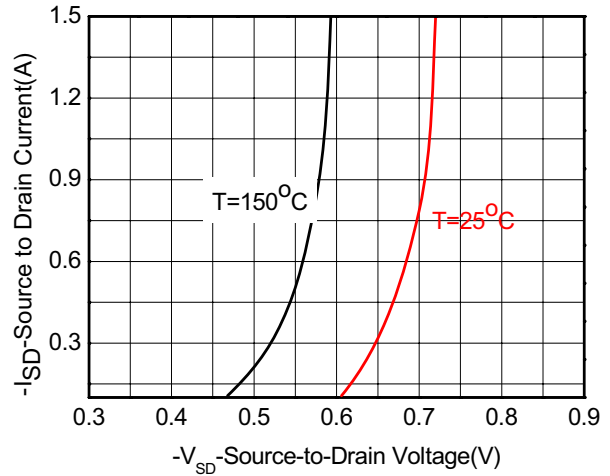
On-Resistance vs. Drain current

On-Resistance vs. Gate-to-Source voltage

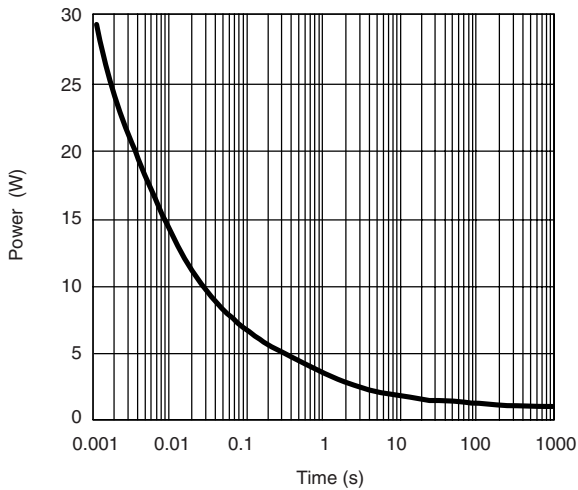
On-Resistance vs. Junction temperature

Threshold voltage vs. Temperature



Capacitance



Drain-to-Source diode forward voltage



Single pulse power

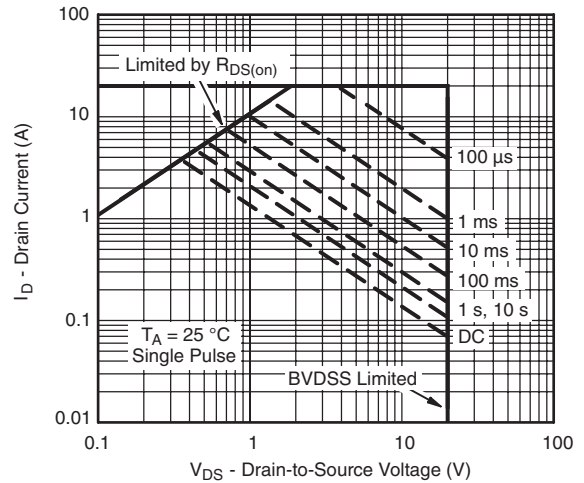

Safe operating power

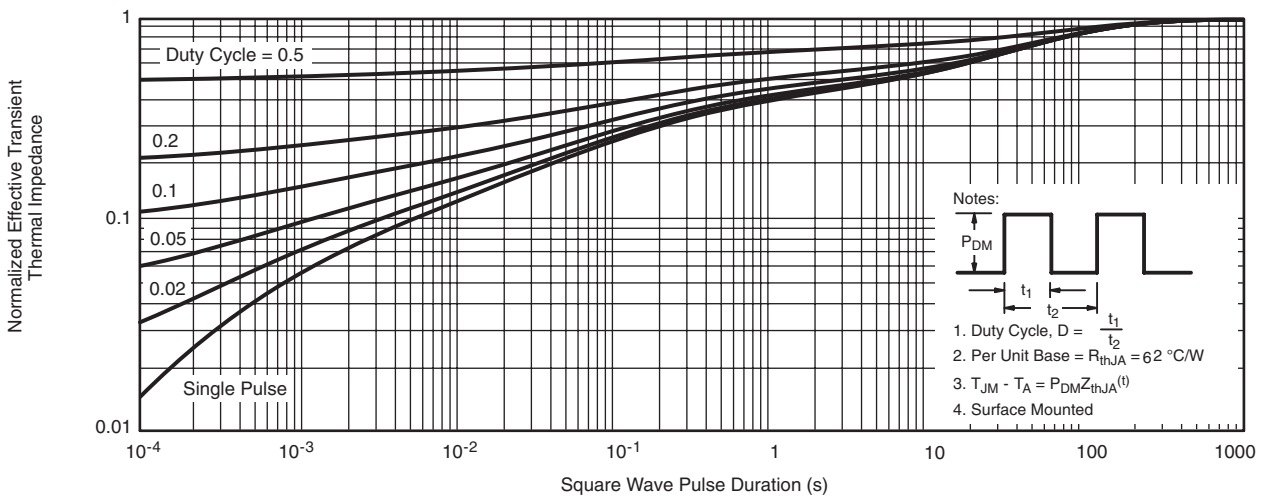

Transient thermal response (Junction-to-Ambient)

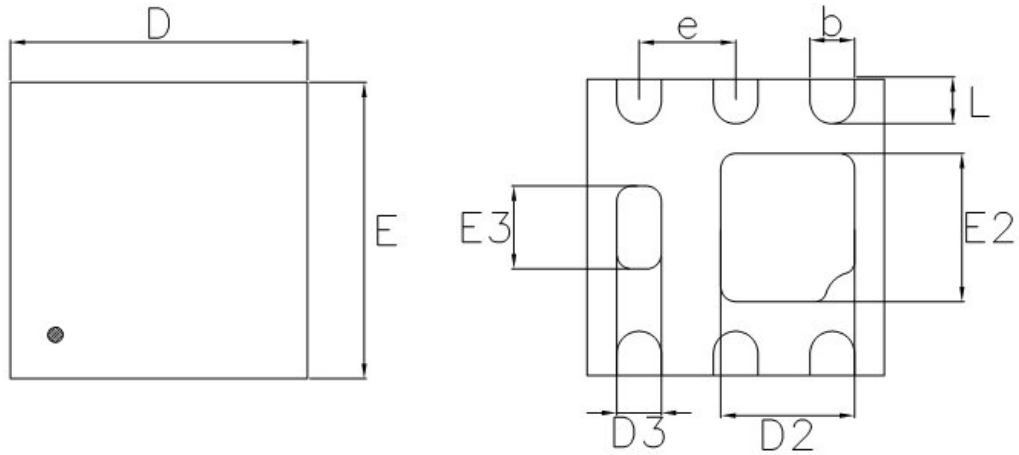
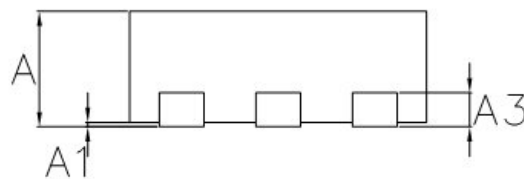
Package outline dimensions
DFN2x2-6L

Top view
Bottom view

Side View

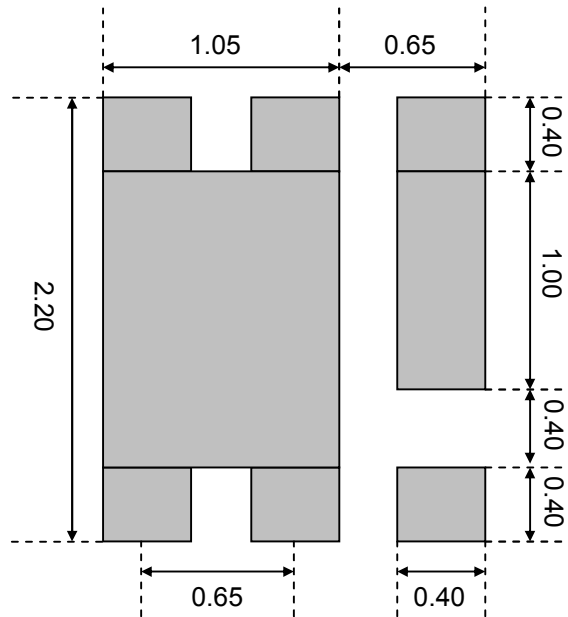
Symbol	Dimensions in millimeter		
	Min.	Typ.	Max.
A	0.70	0.75	0.80
A1	0.00	-	0.05
A3	0.20 Ref.		
D	1.95	2.00	2.05
E	1.95	2.00	2.05
D2	0.85	0.90	0.95
E2	0.95	1.00	1.05
D3	0.25	0.30	0.35
E3	0.51	0.56	0.61
b	0.25	0.30	0.35
L	0.25	0.30	0.30
e	0.65 BSC.		

**Recommend PCB Layout
(Unit: mm)**

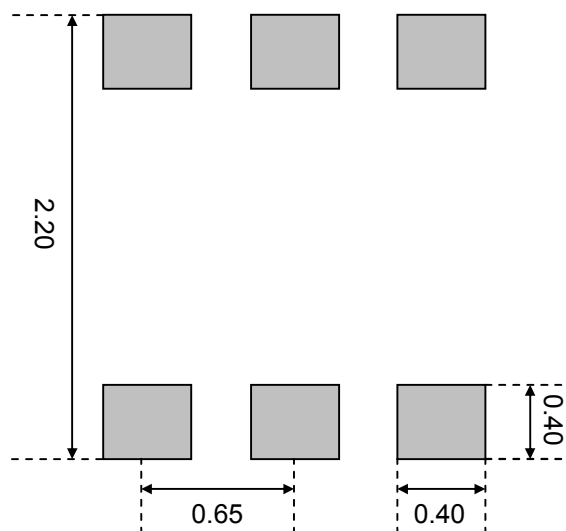

Option 1: High power applications



Option 2: Normal applications