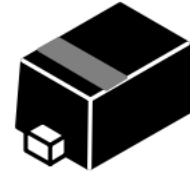
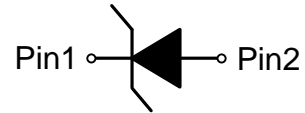

ESD5Z7V
1-Line, Uni-directional, Transient Voltage Suppressors
<http://www.sh-willsemi.com>
Descriptions

The ESD5Z7V is a TVS (Transient Voltage Suppressor) designed to protect sensitive electronic components which are connected to power lines, low speed data lines and transmission lines from over-stress caused by ESD (Electrostatic Discharge), EFT (Electrical Fast Transients) and surge.

The ESD5Z7V may be used to provide ESD protection up to $\pm 30\text{kV}$ (contact discharge) according to IEC61000-4-2, and withstand peak pulse current up to 9.5A (8/20 μs) according to IEC61000-4-5.

The ESD5Z7V is available in SOD-523 package. Standard products are Pb-free and Halogen-free.

SOD-523

Circuit diagram
Features

- Stand-off voltage: 7V Max
- Transient protection for each line according to IEC61000-4-2 (ESD): $\pm 30\text{kV}$ (contact and air discharge)
IEC61000-4-4 (EFT): 80A (5/50ns)
IEC61000-4-5 (surge): 9.5A (8/20 μs)
- Capacitance: $C_J = 47\text{pF}$ typ.
- Low leakage current
- Low clamping voltage
- Solid-state silicon technology

Applications

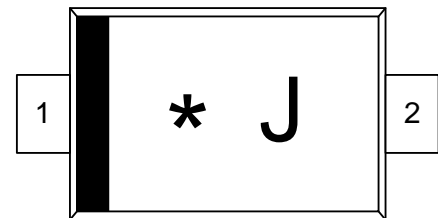
- Computers and peripherals
- Cellular handsets
- Microprocessors
- Power lines
- Portable Electronics
- Notebooks



J = Device code

* = Month code

Marking & Pin configuration (Top View)
Order information

Device	Package	Shipping
ESD5Z7V-2/TR	SOD-523	3000/Tape&Reel

Absolute maximum ratings

Parameter	Symbol	Rating	Unit
Peak pulse power ($t_p = 8/20\mu s$)	P_{PK}	171	W
Peak pulse current ($t_p = 8/20\mu s$)	I_{PP}	9.5	A
ESD according to IEC61000-4-2 air discharge	V_{ESD}	± 30	kV
ESD according to IEC61000-4-2 contact discharge		± 30	
Operation junction temperature	T_J	125	$^{\circ}C$
Lead temperature	T_L	260	$^{\circ}C$
Storage temperature	T_{STG}	-55~150	$^{\circ}C$

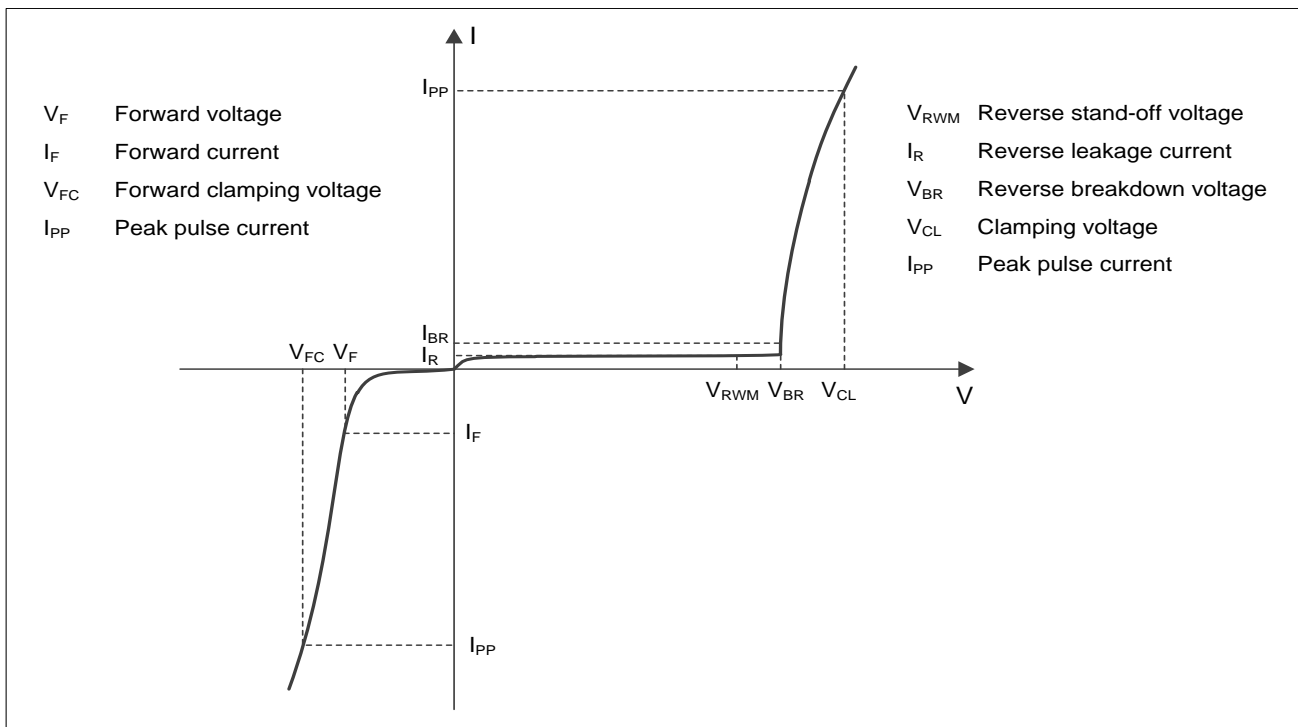
Electrical characteristics ($T_A = 25^{\circ}C$, unless otherwise noted)

Definitions of electrical characteristics

Electrical characteristics ($T_A = 25^\circ\text{C}$, unless otherwise noted)

Parameter	Symbol	Condition	Min.	Typ.	Max.	Unit
Reverse stand-off voltage	V_{RWM}				7	V
Reverse leakage current	I_R	$V_{RWM} = 7V$			1	μA
Reverse breakdown voltage	V_{BR}	$I_{BR} = 1\text{mA}$	7.5		10	V
Forward voltage	V_F	$I_F = 20\text{mA}$	0.55		1.25	V
Clamping voltage ¹⁾	V_{CL}	$I_{PP} = 1\text{A}, t_p = 8/20\mu\text{s}$			12	V
		$I_{PP} = 9.5\text{A}, t_p = 8/20\mu\text{s}$			18	V
Junction capacitance	C_J	$V_R = 0V, f = 1\text{MHz}$		47	65	pF

Notes:

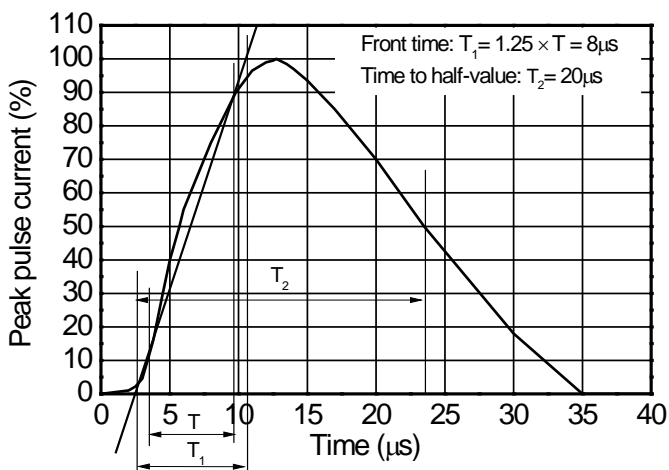
1) Non-repetitive current pulse, according to IEC61000-4-5.

Typical characteristics ($T_A = 25^\circ\text{C}$, unless otherwise noted)

8/20 μs waveform per IEC61000-4-5

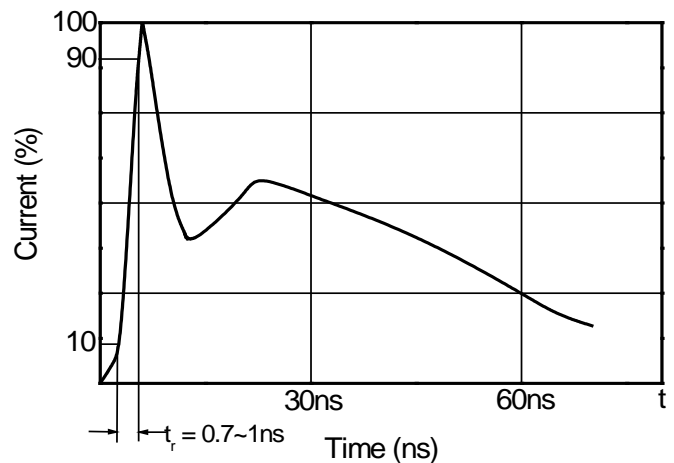

Contact discharge current waveform per IEC61000-4-2

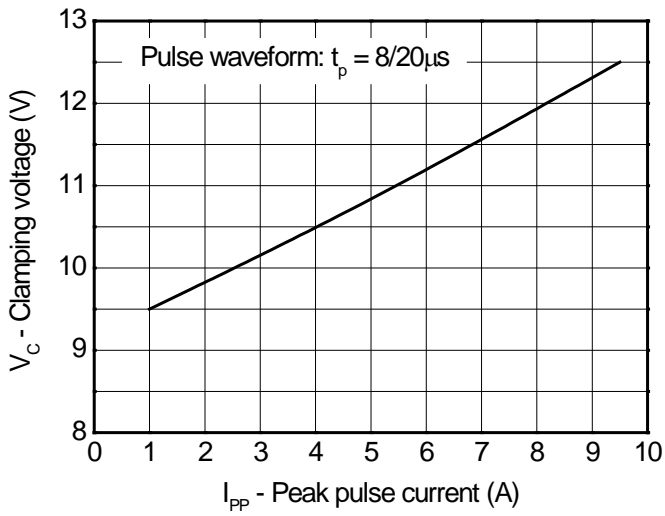
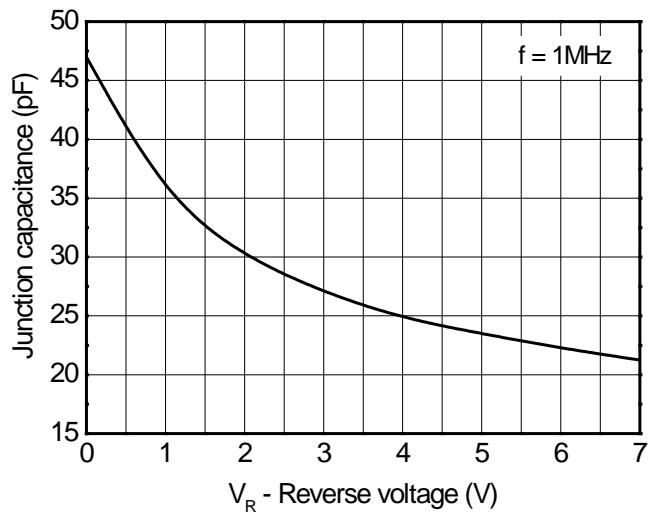
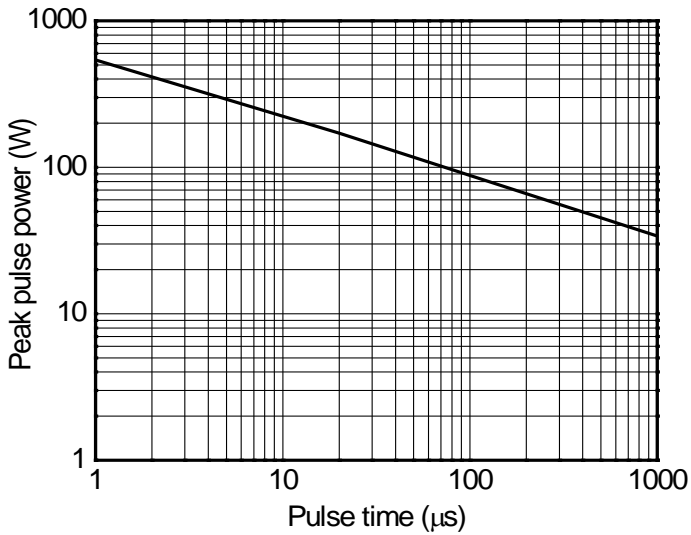
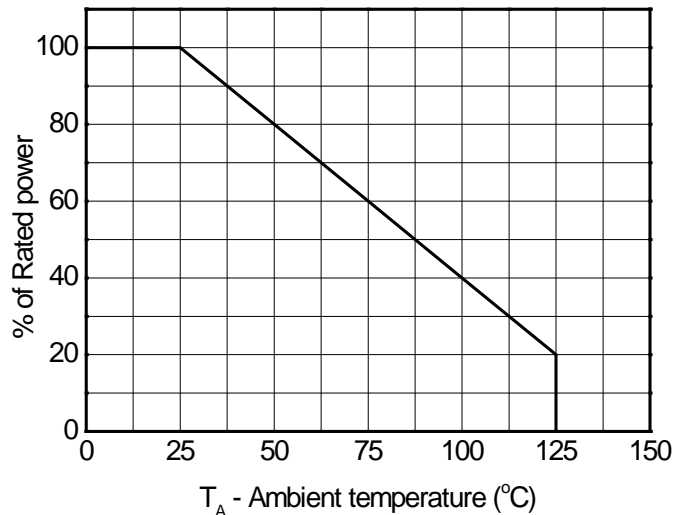
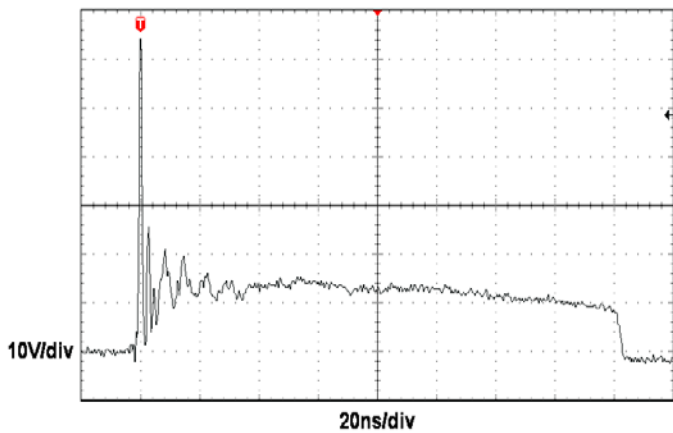
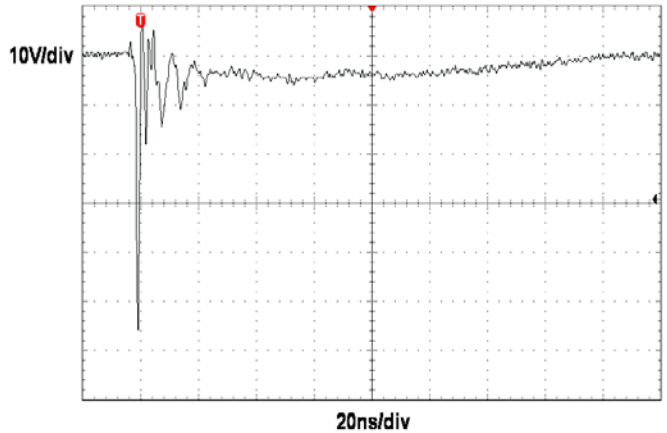
Typical characteristics ($T_A = 25^\circ\text{C}$, unless otherwise noted)

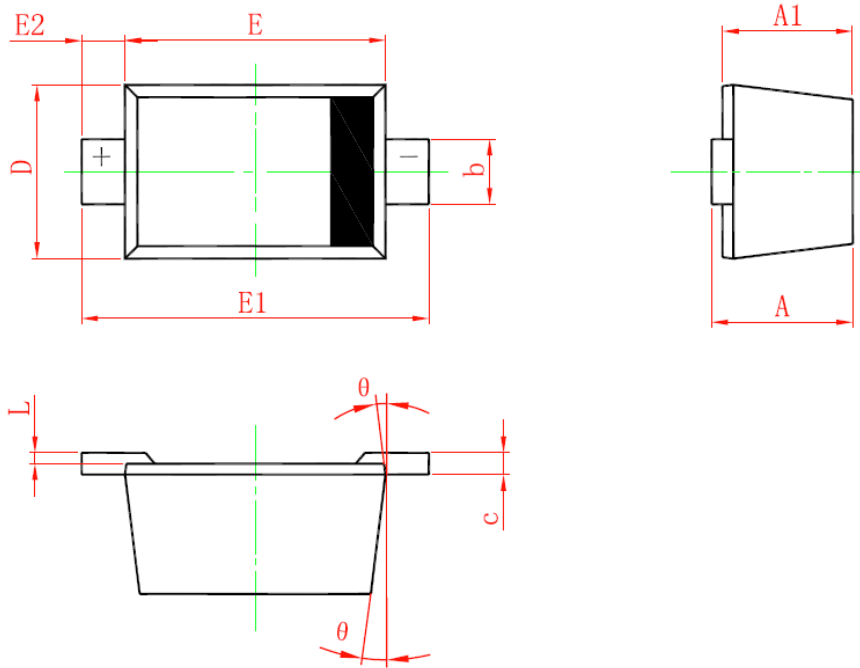
Clamping voltage vs. Peak pulse current

Capacitance vs. Reverse voltage

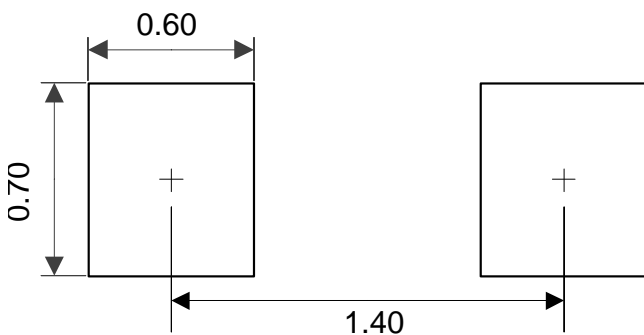
Non-repetitive peak pulse power vs. Pulse time

Power derating vs. Ambient temperature

**ESD clamping
(+8kV contact discharge per IEC61000-4-2)**

**ESD clamping
(-8kV contact discharge per IEC61000-4-2)**

Package outline dimensions
SOD-523

Symbol	Dimensions In Millimeters		
	Min.	Typ.	Max.
A	0.510	--	0.770
A1	0.500	--	0.700
b	0.250	0.300	0.350
c	0.080	--	0.150
D	0.750	0.800	0.850
E	1.100	1.200	1.300
E1	1.500	1.600	1.700
E2	0.200 REF.		
L	0.010	--	0.070
theta	7° REF.		

Recommend Land Pattern (Unit: mm)

Notes:

This recommended land pattern is for reference purposes only. Please consult your manufacturing group to ensure your PCB design guidelines are met.